

DETAILS EXPLANATIONS**EE : Paper-1 (Paper-5) [Full Syllabus]****[PART : A]**

1. It can store large number of data bits. The storage is non-variable and is not erased if power is disconnected. The only disadvantage of this memory is that access time is high. This is because of the reason that data has to be accessed serially. Random access is not possible.
2. It states that "The current through, or voltage across, an element in a linear circuit (having more than one independent source) is equal to the algebraic sum of the currents or voltages produced independently by each source acting alone while all other sources are set to zero".
3. The peak factor or crest factor or amplitude factor of a waveform is defined as the ratio of its peak (or maximum) value to its rms value. Thus, Peak factor,

$$K_p = \frac{V_m}{V_{rms}}$$

4. It is a unique set with respect to a given tree of a connected graph containing one chord and all of the free branches contained in the free path formed between two vertices of the chord.
5. (i) It consists of all the nodes of the graph.
(ii) If the graph has N number of nodes, the tree will have (N – 1) Branches.
(iii) There will be no closed path in the tree.
(iv) There can be many possible different trees for a given graph depending on the number of nodes and branches.

6.
$$Z_{input} = -j4 + \frac{j2(2-j2)}{j2+2-j2}$$

$$= -j4 + \frac{j4+4}{2}$$

$$= -j4 + 2 + j2$$

$$= (2 - j2) = 2.828 \angle -45^\circ \Omega$$

∴ Input p.f. is $\cos 45^\circ = 0.707$ (lead)

7. The usual value of primary distribution voltage in India is 11 kV but in case of high load density area it may be higher (33 or 66 kV) even.
8. Since only out of balance current flows through the middle or neutral wire, so generally neutral wire is taken of half cross section of either outer.
9. A bundled conductor is a conductor made of two or more sub-conductors and is used as one phase conductor. The inductive reactance of the bundle conductors is reduced because the self GMD of the conductor is increased.

$$L = 2 \times 10^{-7} \log_e \left[\frac{D_m}{D_{SA}} \right] \frac{H}{m}$$

By bundling the conductors the self GMD of the conductors is increased thereby, the critical disruptive voltage is increased and hence corona loss is reduced.

10. When the line compensating device is connected in series with the line, series compensation is achieved and when connected across the line, shunt compensation is achieved.
11. (i) Starting of a synchronous motor by mean of damper winding.
(ii) Starting of a synchronous motor first as slip-ring induction motor and then as a synchronous motor.
12. A synchronous condenser is an overexcited synchronous motor whose primary function is to improve the power factor of an electrical system. It does so by delivering reactive power to the AC system. A synchronous condenser has no shaft extension, because it is not designed to deliver any mechanical load.
13. By armature reaction of a synchronous machine, we mean how armature flux produced by 3-phase armature winding affected the distribution of main-field flux created by DC in the field winding.
14. Open circuit test is to determine iron loss, As iron loss depends upon the applied voltage. So it is performed at rated voltage hence it is performed on L.V. side.

Short circuit test is performed to determine cu loss. As cu loss depends upon load current so short circuit test is performed at rated current to flow the rated current in short circuit condition reduced voltage upto 5% of rated voltage is required. So short circuit test is performed at H.V. side or Low current side.

$$15. \quad \eta = \frac{P_0}{P_{in}} = \frac{P_0}{P_0 + P_L}$$

$$\eta = \frac{xS_0 \cos \phi}{xS_0 \cos \phi + P_i + x^2 P_{CF}}$$

$$P_0 = xS_0 \cos \phi$$

P_{in} = Power output + Losses

Where S_0 = Transformer capacity (VA)

x = Percentage load (P.U.)

P_i = Iron losses

P_{CF} = Full load cu losses.

16. The voltage regulation of a transformer is the arithmetical difference in the secondary terminal voltage between no load and full load at a given power factor with the same value of primary voltage for both no load and full load.

$$V.R. = \frac{V_{nl} - V_{fl}}{V_{fl}} \times 100$$

$$V.R. = x[R_{pu} \cos \phi + x_{pu} \sin \phi]$$

Where V_{nl} = Voltage at no load

V_{fl} = Full load voltage

x = Per unit load

R_{pu} = Resistance in p.u.

X_{pu} = Reactance in p.u.

17. (i) Loss i.e. iron loss = 0, cu loss = 0

$$\text{i.e. } R_1 \text{ and } R_2' = 0, P_i = \frac{E_1^2}{R_i} = 0$$

$$\Rightarrow R_i = \infty$$

(ii) No leakage flux i.e. leakage reactance are zero.

(iii) $\phi_m \neq 0$ but $I_m = 0$ i.e. $X_m = \infty$ or $L_m = \infty$

$$\phi_m = \frac{\text{mmf}}{\text{Reluctance}} = \frac{N_1 I_m}{\xi}$$

$$\text{Reluctance } (\xi) = \frac{l}{\mu_0 \mu_r A}$$

$$\mu_r = \infty$$

18. Series compensation is provided in EHV transmission lines to artificially reduce the series reactance of the line, that results in improvement of stability, voltage regulation and transmission efficiency.
19. The main functions of protective relays are to detect the presence of faults, their locations and initiate the action for quick removal from service of the faulty section of the system. Relays operate to trip the power circuit breakers to disconnect the faulty section.
20. Induction cup type construction develops more efficient torque than either shaded pole or watt-hour meter constructions. Such relays are very fast in operation and may have an operating time of less than 0.01 second.

[PART : B]

21. Surge impedance loading (SIL) or natural load is the load that can be delivered by a line having no resistance and the loading being driven at unity power factor. The 'natural power' or 'surge impedance loading' of a transmission line is given as

$$P_R = \frac{V_{RL}^2}{Z_0} \text{ MW}$$

Where, V_{RL} = The receiving end voltage in kV
and Z_0 = The surge impedance in ohm.

The above expression gives a limit of the maximum power that can be delivered by a line and is useful in the design of transmission lines. This can be used for the comparison of loads that can be carried on the transmission lines at different voltages.

22. **Ideal Voltage Sources**

An ideal voltage source provides a prescribed voltage across its terminals irrespective of the current flowing through it. The amount of current supplied by the source is determined by the circuit connected to it. Figure depicts the symbol used to represent ideal voltage sources.

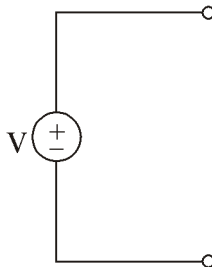

Figure : Ideal Voltage Source

Ideal Current Source

An ideal current source provides a prescribed current to any circuit connected to it. The voltage generated by the source is determined by the circuit connected to it. Figure depicts the symbol used to represent ideal current sources.

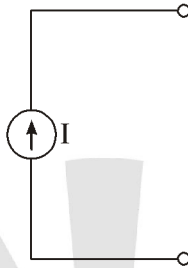

Figure : Ideal Current Source

$$\begin{aligned}
 23. \quad Z_{in} &= j10 + \frac{(1+j1)(1-j2)}{1+j1+1-j2} = j10 + \frac{1+j1-j2+2}{2-j1} \\
 &= j10 + \frac{(3-j1)(2+j1)}{2^2+1^2} = j10 + \frac{6+j3-j2+1}{5} \\
 &= j10 + 1.4 + j0.2 = 1.4 + j10.2 \\
 &= 10.3 \angle 82.18^\circ \Omega
 \end{aligned}$$

$$\therefore I = \frac{V}{Z_{in}} = \frac{10 \angle 0^\circ}{10.3 \angle 82.18^\circ} = 0.97 \angle -82.18^\circ \text{A}$$

[Lagging current]

24. Rated voltage V_o at $V = 0.5 V_o$ half of rated blocked rotor current

$$I_{2sc} = 3I_{fl} \text{ in blocked rotor } N_r = 0 \Rightarrow S = 1.$$

$$I_{2sc} = \frac{V}{Z_{sc}} = 3I_{fl}$$

$$\Rightarrow Z_{sc} = \frac{V}{3I_{fl}} = \frac{0.5V}{3I_{fl}}$$

At Rated voltage

$$I_{sc} = \frac{V_o}{Z_{sc}} = \frac{V_o}{0.5V_o / 3I_{fl}} = 6I_{fl}$$

Starting torque

$$T_s = \frac{3}{\omega_s} \frac{V^2 R_2'}{(R_1 + R_2')^2 + X^2}$$

$$\Rightarrow \frac{T_s}{T_{so}} = \left(\frac{V}{V_o} \right)^2$$

At rated voltage

$$T_{so} = \frac{3}{\omega_s} \frac{V_o^2 R_2'}{(R_1 + R_2')^2 + X^2}$$

$$\Rightarrow \frac{0.4T_{fl}}{T_{so}} = (0.5)^2$$

Using auto transformer with a tapping x, starting.

$$\Rightarrow T_{so} = 1.6T_{fl}$$

Current drawn from supply

$$I_1 = x^2 I_{sc}$$

Starting torque

$$T_{st} = x^2 T_{so}$$

$$I_1 = x^2 I_{sc} = 1.4 I_{fl} = x^2 \times 6 \times I_{fl} = 1.4 I_{fl}$$

Starting torque

$$T_{st} = \frac{1.4}{6} \times 1.6T_{fl} \Rightarrow x^2 = \frac{1.4}{6}$$

$$= 0.3733T_{fl} = 37.33\%$$

25. All the appliances and motors are designed to be operated at a particular or declared value of voltage. Large voltage variation means either a too high or a too low voltage. Low voltage will cause not only in burning of motors/appliances/equipment and insufficient lighting but also loss of revenue to the supplier. On the other hand high voltage will cause the lamps to burn out permanently and also may cause failure of other appliances. So the primary requirement of a distribution system is that voltage variations at the consumer's terminals should be the lowest possible (not more than $\pm 6\%$ of the rated value).
26. The resistivity ρ (Scattering phenomenon)

$$= \frac{m}{ne^2} \left[\frac{1}{\tau_i} + \frac{1}{\tau_T} \right]$$

∴ Percentage of impurity

$$\begin{aligned}
 &= \frac{\sigma_{\text{actual}} - \sigma_{\text{meas}}}{\sigma_{\text{actual}}} \times 100\% \\
 &= \frac{(1/\rho_{\text{actual}}) - (1/\rho_{\text{meas}})}{(1/\rho_{\text{actual}})} \times 100\% \\
 &= \frac{(1/1.73) - (1/1.74)}{(1/1.73)} \times 100\% = 0.574\%
 \end{aligned}$$

27. $(\epsilon_r \cos \theta_2 + \epsilon_x \sin \theta_2 = VR_{pu})$

Equation shows that VR varies with load power factor. If load factor is varies with constant value of load current and secondary emf, then zero voltage regulation will occur when

$$\epsilon_r \cos \theta_2 + \epsilon_x \sin \theta_2 = 0$$

$$\tan \frac{\theta}{2} = -\frac{\epsilon_r}{\epsilon_x} = -\frac{I_2 I_{e2}}{E_2 \frac{I_2 X_{e2}}{E_2}} = -\frac{r_{e2}}{X_{e2}}$$

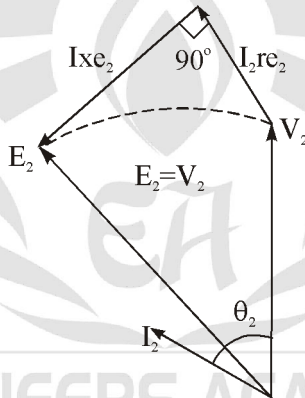

Figure : Phasor Diagram for 1-φ transformer for zero V.R.

∴ Magnitude of load p.f., $\cos \theta_2 = \frac{X_{e2}}{Z_{e2}}$

The negative value of $\tan \theta_2$ indicates a leading pf therefore, zero voltage regulation occurs when load pf is $\frac{X_{e2}}{Z_{e2}}$ leading for leading

pfs greater than $\frac{X_{e2}}{Z_{e2}}$, the voltage regulation will be negative, i.e., the voltage will rise from its no load value as the transformer load is increases.

28. Earth wire is provided above overhead transmission lines for protection from lightning strokes. The ground wire shields the phase or line conductors by attracting itself the lightning strokes which, in its absence would strike the phase conductors. Besides it, the ground wire reduces the voltage electrostatically or electromagnetically induced in the conductors by the discharge of a neighbouring cloud. It also provides additional protective effect by causing attenuation of travelling waves set in lines by acting as a short circuited secondary of the line conductors.
29. **Following disadvantage of Auto transformer :**
- If the ratio of transformation k differs from unity, the economic advantages of auto transformer over two winding transformer decreases.
 - The main disadvantage of an auto-transformer is due to the direct electrical connection between the low-tension and high tension side. If primary is supplied at high voltage, then an open circuit in the common winding, would result in the appearance of dangerously high voltage on the low voltage (LV) side this high voltage may be detrimental to the load and the persons working there, thus a suitable protection must be provided against such an occurrence.
 - The short circuit current in an auto-transformer is higher than that in a corresponding two-winding transformer.
30. For detect correct place for brush following procedure may be adopted.
- Run the machine at rated speed as a DC generator, first in one direction and then in the opposite direction. for the same field and armature currents. If the terminal voltage for both the direction of rotation are the same, then the brushes are placed correctly along the quadrature axis.
 - Alternatively, run the machine as a DC motor, first in one direction and then in opposite direction, for the same field and armature currents, if the rotor speed turns out to be the same for both directions of rotation. Then the brushes are placed correctly along the quadrature axis.
 - If the brushes get shifted from the quadrature axis, then the terminal voltage in case of generator or speed in case of motor, for both the direction of rotation, would not be equal.
31. **Ferrimagnetic Materials :**
- In ferrimagnetic substances the magnetic moment of adjacent atoms are alligned in opposite direction but the moments are not equal so that there is a net magnetic moment i.e. not zero. However it is less than that of ferromagnetic materials. They loses these properties above certain temperature called as curie temp. These materials have high value of magnetic susceptibility but less than that of ferromagnetic materials.

Example: Fe_3O_4 , MnFe_2O_4 .

Antiferromagnetic Materials :

In antiferromagnetic materials the magnetic moments of adjacent atoms align in opposite directions so that net magnetic moment of a specimen is null in absence of magnetic field. But on the application of magnetic field dipoles are aligned in direction of magnetic field. The value of magnetic susceptibility is positive and very small.

Example: MnF_2 .

32. Length of distributor, $l = 50$ m

Current loading, $i = 4$ A/m

Resistance per metre run of both of the conductors,

$$r = \frac{2 \times 1}{1000} = 0.002 \text{ } \Omega/\text{m}$$

Maximum voltage drop will occur at mid point and is given by the equation

Maximum voltage drop

$$= \frac{ir^2}{8} = \frac{4 \times 0.002 \times (50)^2}{8} = 2.5 \text{ V}$$

[PART : C]

33. (i) *Old base kVA* = 30000 kVA

Old base kV = 11 kV

Old per unit impedance,

$$Z_{pu \text{ old}} = 0.2 \text{ pu}$$

New base kVA = 50000 kVA

New base kV = 33 kV

New per unit impedance,

$$\begin{aligned} Z_{pu \text{ new}} &= Z_{pu \text{ old}} \times \frac{\text{New base kVA}}{\text{Old base kVA}} \times \left(\frac{\text{Old base kV}}{\text{New base kV}} \right)^2 \\ &= 0.2 \times \frac{50000}{30000} \times \left(\frac{11}{33} \right)^2 = 0.037 \text{ pu} \end{aligned}$$

(ii) *Span length,*

$$L = 220 \text{ m}$$

Weight of conductor per metre length,

$$w = \frac{604}{1,000} \text{ kg} = 0.604 \text{ kg}$$

Ultimate tensile length = 5,758

Factor of safety = 2

Working tension,

$$T = \frac{\text{Ultimate tensile strength}}{\text{Factor of safety}}$$

$$= \frac{5,758}{2} = 2,879 \text{ kg}$$

Maximum sag,

$$S = \frac{\omega L^2}{8T} = \frac{0.604 \times 220^2}{8 \times 2,879} = 1.269 \text{ m}$$

34. $Z = \frac{V}{I} = \frac{10}{1} = 10 \Omega$ [$\because V = 10V, I = 1 A$]

But $Z = \sqrt{R^2 + (\omega L)^2}$

$\therefore (\omega L)^2 = Z^2 - R^2 = 10^2 - 5^2 = 75$

Thus $L = \sqrt{\frac{75}{\omega^2}} = 0.0276 \text{ H}$

i.e., 27.6 mH

The inductance of the circuit is 27.6 mH.

The p.f. of the given circuit is,

$$\cos \phi = \frac{R}{Z} = \frac{5}{10} = 0.5$$

Then, for the given circuit,

$$L = 27.6 \text{ mH}; \cos \phi = 0.5 \text{ (lag)}.$$

35. It is seen from the phasor diagram of a reluctance motor figure that

$$I_d = I_a \sin(\theta - \delta)$$

and $I_Q = I_a \cos(\theta - \delta)$

or $\frac{I_Q}{I_d} = \frac{\cos(\theta - \delta)}{\sin(\theta - \delta)}$

and $V_t \sin \delta = I_Q x_Q$
 $V_t \cos \delta = I_d x_d$

or $\tan \delta = \frac{I_Q}{I_d} \cdot \frac{x_Q}{x_d}$

or $\frac{I_Q}{I_d} = \frac{x_Q}{x_d} \cdot \tan \delta$

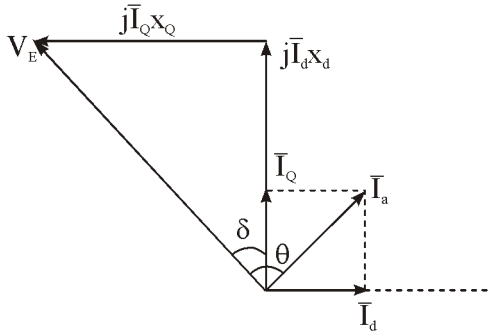

Figure : Reluctance motor phasor diagram with $r_a = 0$

For above equation we get

$$\frac{X_d}{X_q} \tan \delta = \frac{\cos(\theta - \delta)}{\sin(\theta - \delta)}$$

Under maximum power conditions, reluctance motor operates $\delta = 45^\circ$.

$$\therefore \frac{X_d}{X_q} \cdot 1 = \frac{\cos \theta \times 0.707 + \sin \theta \times 0.707}{\sin \theta \times 0.707 - \cos \theta \times 0.707}$$

$$\text{or } \frac{X_d}{X_q} = \frac{\sin \theta + \cos \theta}{\sin \theta - \cos \theta}$$

$$\text{or } \frac{(\sin \theta + \cos \theta) + (\sin \theta - \cos \theta)}{(\sin \theta + \cos \theta) - (\sin \theta - \cos \theta)} = \frac{X_d + X_q}{X_d - X_q}$$

$$\therefore \frac{\sin \theta}{\cos \theta} = \tan \theta = \frac{X_d + X_q}{X_d - X_q}$$

Under maximum power condition, reluctance motor operates at a lagging pf.

36. Maxwell's equation indifferently and intergal form derivations.

Differential form

$$\nabla \times \bar{H} = J_c + J_d = \epsilon E + \frac{d}{dt} E \quad \dots(1)$$

Ampear's law

$$\oint \bar{H} \cdot d\bar{l} = I_{enc}$$

$$\oint_C (\nabla \times \bar{H}) \cdot d\bar{s} = \int_C (\nabla \times \bar{H}) \cdot d\bar{s} = \int_s \bar{J}_{eq} \cdot d\bar{s} \quad \dots(2)$$

By Continuity equation

$$q = i.t. \Rightarrow I = \frac{d}{dt} q$$

$$I = \frac{d}{dt} \int \bar{E} \cdot \bar{ds}$$

$$\int \bar{H} \cdot \bar{dl} = \int (\bar{\nabla} \times \bar{H}) \cdot \bar{ds} = \frac{d}{dt} \int \bar{E} \cdot \bar{ds}$$

$$\bar{\nabla} \times \bar{H} = \frac{d}{dt} \bar{E} \quad \dots(3)$$

Combining all 3 equation we get

$$\bar{\nabla} \times \bar{H} = \epsilon \bar{E} + \frac{d}{dt} \bar{E}$$

$$\bar{\nabla} \times \bar{E} = \mu \frac{d\bar{H}}{dt} \quad \text{--Maxwell's 2nd Equation}$$

Faraday's Law :

$$\bar{V} = -\frac{d}{dt} \int \bar{B} \cdot \bar{ds}$$

$$\bar{V} = \int_C \bar{E} \cdot \bar{dl} = \int (\bar{\nabla} \times \bar{E}) \cdot \bar{ds} = -\frac{d}{dt} \int \bar{B} \cdot \bar{ds}$$

$$\bar{\nabla} \times \bar{E} = -\mu \frac{d\bar{H}}{dt}$$

Maxwell's IIIrd Equation :

$$\bar{\nabla} \cdot \bar{D} = P_v$$

According to Gams Low :

$$Q_{enc} = \oint_s \bar{D} \cdot \bar{ds}$$

$$\int_v P_v \cdot dv = \int_v (\bar{\nabla} \cdot \bar{D}) = \bar{\nabla} \cdot \bar{D} = \rho_v$$

Maxwell's -IV

$$\bar{\nabla} \cdot \bar{B} = 0$$

Because in magnetic field no divergence loss occur.

Maxwell's equation in integral form

$$1. \quad \oint_s \bar{D} \cdot \bar{ds} = Q_{enc} = \text{Amount of charge in this surface } s.$$

$$2. \quad \oint_L \bar{E} \cdot \bar{dl} = -\int_s \frac{d}{dt} (\bar{B} \cdot \bar{ds})$$

$$3. \oint_L \vec{H} \cdot d\vec{l} = I_{\text{enc}} + \iint \frac{d}{dt} \vec{D} \cdot d\vec{s} = I_{\text{enc}} = \iint_s \vec{J} \cdot d\vec{s}$$

$$4. \oint_s \vec{B} \cdot d\vec{s} = 0$$

37. Intrinsic impedance is define as the ratio of magnitude of transverse electric field intensity to magnitude transverse magnetic field intensity.

$$\frac{E_0}{H_0} = \sqrt{\frac{j\omega\mu}{\sigma + j\omega\epsilon}} = \eta$$

$$E(z, t) = R_e[E_s \times e^{j\omega t}]$$

$$E(z, t) = 200 \cos(\omega t - 250z + 30) \hat{a}_x$$

(i)

$$\vec{k} = 250 \hat{a}_x$$

⇒

$$\beta = |\vec{k}| = 250 \text{ rad/m}$$

(ii)

$$\beta = \frac{2\pi}{\lambda}$$

⇒

$$\lambda = \frac{2\pi}{250} = 2.5 \text{ cm}$$

(iii)

$$\rho = \frac{\omega}{C}$$

⇒

$$\omega = 250 \times C$$

$$\omega = 250C = 75 \text{ Grad/sec}$$

$$(iv) \quad \eta_0 = \sqrt{\frac{\mu_0}{\epsilon_0}} = 120 \pi \Omega$$

$$(v) \quad H = \frac{1}{\eta} [\hat{k} \times E]$$

$$= \frac{200}{120\pi} \cos(\omega t - 250z + 30^\circ) [\hat{a}_z \times \hat{a}_x]$$

$$H = \frac{10}{6\pi} \cos(\omega t - 250z + 30^\circ) \hat{a}_y \text{ A/m}$$

38. An induction motor with two rotor windings or cages is used for obtaining high starting torque at low starting current. In the double cage rotor there are two layers of bar as shown in figure.

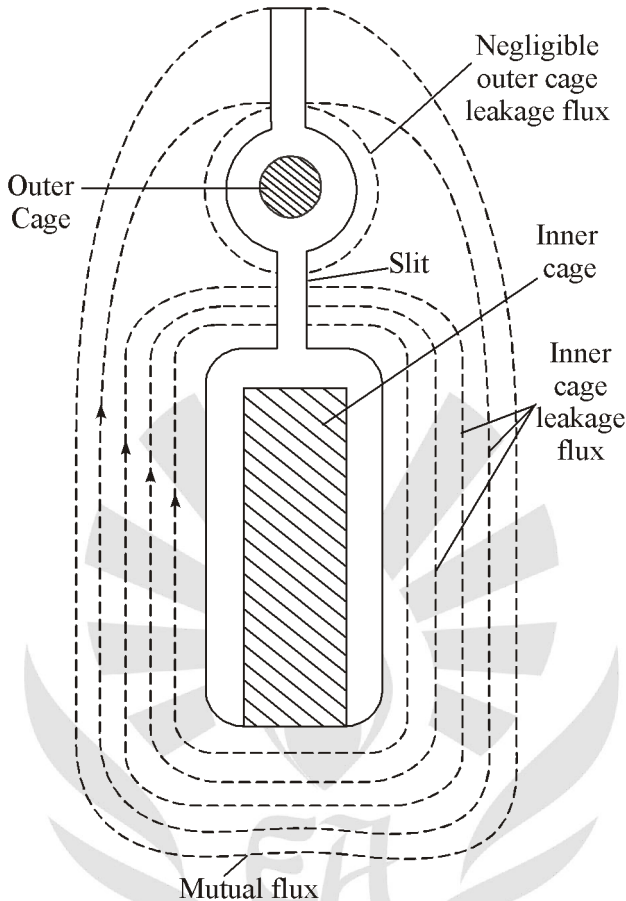

Figure : Double-Cage Rotor Slot

Each layer is short circuited by end rings the outer cage bars have a smaller cross-sectional area than the inner bars are made of high resistivity materials like brass, aluminium, bronze etc. the inner-cage bars are made of low resistance of the inner-cage. There is a slit between the top and bottom slats. The slit increases permeance for leakage flux around the inner-cage bars. Thus, the leakage flux linking the inner-cage winding is much larger than that of the outer-cage winding, and the inner winding, therefore, has a greater self inductance. At starting, the voltage induced in the rotor is same as the supply frequency ($f_2 = f_1$). Hence, the leakage reactance of the inner-cage winding ($= 2\pi fL$) is much larger than that of the outer-cage winding. Therefore most of the starting current is flowing in the outer-cage winding which offers low-impedance to the flow of current. The high resistance outer-cage winding, therefore, develops a high starting torque.

As the rotor speed increases, the frequency of the rotor emf ($f_r = sf$) decreases, at normal operating speed, the leakage reactance ($= 2\pi sfL$) of both the windings become negligible small. The rotor current division between the two cages is governed mainly by their resistances. Since the resistance of the outer cage is about 5 to 6 times that the inner cage, most of the rotor current flow through inner cage. Hence under normal operating speed, torque is developed mainly by the low-resistance inner cage.

Equivalent circuit of double-cage induction motor :

It is assume that the main flux completely links both the cages, the impedance of the two cages can be considered in parallel.

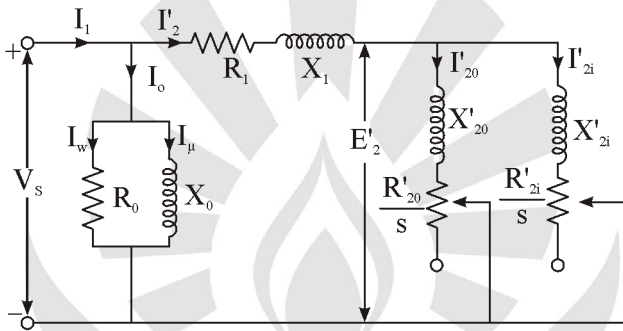

Figure : Equivalent Circuit of Double Cage Induction Motor.

The equivalent circuit of the double-cage induction motor at slip s is shown in figure. If the shunt branches containing R_0 and X_0 are neglected, the equivalent circuit is simplified to that shown in figure.

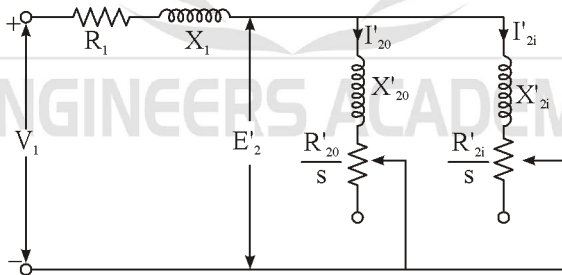

Figure: Approximate Equivalent Circuit of Double Cage Induction Motor with Magnetising Current Neglected.

As slip s , the outer cage impedance, $Z'_{20} = \frac{R'_{20}}{s} + jX'_{20}$

At slip s , the inner cage impedance $Z'_{2i} = \frac{R'_{2i}}{s} + jX'_{2i}$

39. Radius of each conductor,

$$r = \frac{0.5}{2} \text{ cm} = 0.25 \text{ cm}$$

Spacing between conductors,

$$d = 1.5 \text{ m} = 150 \text{ cm}$$

Height of conductors above earth,

$$h = 7 \text{ m} = 700 \text{ cm}$$

Capacitance per metre of line,

$$\begin{aligned} C &= \frac{\pi \epsilon_0}{\log_e \frac{d}{\sqrt[3]{1 + (d^2 / 4h^2)}}} \\ &= \frac{\pi \times 8.854 \times 10^{-12}}{\log_e \frac{150}{\sqrt[3]{1 + (150 / 1400)^2}}} \\ &= 4.5 \times 10^{-12} \text{ F/m} \end{aligned}$$

Capacitance of 50 km long,

$$C = 4.5 \times 10^{-12} \times 50 \times 1000 \text{ F} = 0.225 \mu\text{F}$$



ENGINEERS ACADEMY